

Package leaflet: Information for the user

Paliperidone Clonmel 50 mg prolonged-release suspension for injection in pre-filled syringe
Paliperidone Clonmel 75 mg prolonged-release suspension for injection in pre-filled syringe
Paliperidone Clonmel 100 mg prolonged-release suspension for injection in pre-filled syringe
Paliperidone Clonmel 150 mg prolonged-release suspension for injection in pre-filled syringe

paliperidone

Read all of this leaflet carefully before you start using this medicine because it contains important information for you.

- Keep this leaflet. You may need to read it again.
- If you have any further questions, ask your doctor, pharmacist or nurse.
- If you get any side effects, talk to your doctor, pharmacist or nurse. This includes any possible side effects not listed in this leaflet. See section 4.

What is in this leaflet

1. What Paliperidone Clonmel is and what it is used for
2. What you need to know before you use Paliperidone Clonmel
3. How to use Paliperidone Clonmel
4. Possible side effects
5. How to store Paliperidone Clonmel
6. Contents of the pack and other information

1. What Paliperidone Clonmel is and what it is used for

Paliperidone Clonmel contains the active substance paliperidone which belongs to the class of antipsychotic medicines and is used as a maintenance treatment for the symptoms of schizophrenia in adult patients already stabilised on paliperidone or risperidone.

If you have shown responsiveness to paliperidone or risperidone in the past and have mild to moderate symptoms, your doctor may start treatment with Paliperidone Clonmel without prior stabilisation with paliperidone or risperidone.

Schizophrenia is a disease with “positive” and “negative” symptoms. Positive means an excess of symptoms that are not normally present. For example, a person with schizophrenia may hear voices or see things that are not there (called hallucinations), believe things that are not true (called delusions), or feel unusually suspicious of others. Negative means a lack of behaviours or feelings that are normally present. For example, a person with schizophrenia may appear withdrawn and may not respond at all emotionally or may have trouble speaking in a clear and logical way. People with this disease may also feel depressed, anxious, guilty, or tense.

Paliperidone Clonmel can help alleviate the symptoms of your disease and stop your symptoms from coming back.

2. What you need to know before you use Paliperidone Clonmel

DO NOT use Paliperidone Clonmel

- if you are allergic to paliperidone or to any of the other ingredients of this medicine (listed in section 6)
- if you are allergic to another antipsychotic medicine including the substance risperidone

Warnings and precautions

Talk to your doctor, pharmacist or nurse before using Paliperidone Clonmel.

This medicine has not been studied in elderly patients with dementia. However, elderly patients with dementia who are treated with other similar types of medicine may have an increased risk of stroke or death (see section 4, possible side effects).

All medicines have side effects and some of the side effects of this medicine can worsen the symptoms of other medical conditions. For that reason, it is important to discuss with your doctor any of the following conditions which can potentially worsen during treatment with this medicine:

- if you have Parkinson's disease
- if you have ever been diagnosed with a condition whose symptoms include high temperature and muscle stiffness (also known as Neuroleptic Malignant Syndrome)
- if you have ever experienced abnormal movements of the tongue or face (Tardive Dyskinesia)
- if you know that you have had low levels of white blood cells in the past (which may or may not have been caused by other medicines)
- if you are diabetic or prone to diabetes
- if you have had breast cancer or a tumour in the pituitary gland in your brain
- if you have a heart disease or heart disease treatment that makes you prone to low blood pressure
- if you have low blood pressure when you stand up or sit up suddenly
- if you have epilepsy
- if you have kidney problems
- if you have liver problems
- if you have prolonged and/or painful erection
- if you have problems with controlling core body temperature or overheating
- if you have an abnormally high level of the hormone prolactin in your blood or if you have a possible prolactin-dependent tumour
- if you or someone else in your family has a history of blood clots, as antipsychotics have been associated with formation of blood clots

If you have any of these conditions, please talk to your doctor as he/she may want to adjust your dose or monitor you for a while.

- As dangerously low levels of a certain type of white blood cell needed to fight infection in your blood has been seen very rarely with patients taking this medicine, your doctor may check your white blood cell counts.
- Even if you have previously tolerated oral paliperidone or risperidone, rarely allergic reactions occur after receiving injections of Paliperidone Clonmel. Seek medical attention right away if you experience a rash, swelling of your throat, itching, or problems breathing as these may be signs of a serious allergic reaction.
- This medicine may cause you to gain weight. Significant weight gain may adversely affect your health. Your doctor should regularly measure your body weight.
- As diabetes mellitus or worsening of pre-existing diabetes mellitus have been seen with patients taking this medicine, your doctor should check for signs of high blood sugar. In patients with pre-existing diabetes mellitus blood glucose should be monitored regularly.
- Since this medicine may reduce your urge to vomit, there is a chance that it may mask the body's normal response to ingestion of toxic substances or other medical conditions.
- During an operation on the eye for cloudiness of the lens (cataract), the pupil (the black circle in the middle of your eye) may not increase in size as needed. Also, the iris (the coloured part of the eye) may become floppy during surgery and that may lead to eye damage. If you are planning to have an operation on your eye, make sure you tell your eye doctor that you are taking this medicine.

Children and adolescents

This medicine is not for people who are under 18 years old.

Other medicines and Paliperidone Clonmel

Tell your doctor if you are taking, have recently taken or might take any other medicines.

- Taking this medicine with **carbamazepine** (an anti-epileptic and mood stabiliser) may require a change to your dose of Paliperidone Clonmel.
- Since this medicine works primarily in the brain, interference from other medicines that work in the brain can cause an exaggeration of side effects such as sleepiness or other effects on the brain such as other **psychiatric medications, opioids, antihistamines and sleep medication**.
- Since this medicine can lower blood pressure, care should be taken when this medicine is used with other **medicines that lower blood pressure**.
- This medicine can reduce the effect of medicines against **Parkinson's disease and restless legs syndrome (e.g. levodopa)**.
- This medicine may cause an electrocardiogram (ECG) abnormality demonstrating a long time for an electrical impulse to travel through a certain part of the heart (known as "QT prolongation"). Other medicines that have this effect include some **medicines used to treat the rhythm of the heart or to treat infection, and other antipsychotics**.
- If you are prone to develop convulsions, this medicine may increase your chance of experiencing them. Other medicines that have this effect include some **medicines used to treat depression or to treat infection, and other antipsychotics**.
- Paliperidone Clonmel should be used with caution with medicines that increase the activity of the central nervous system (**psychostimulants such as methylphenidate**).

Paliperidone Clonmel with alcohol

Alcohol should be avoided.

Pregnancy and breast-feeding

If you are pregnant or breast-feeding, think you may be pregnant or are planning to have a baby, ask your doctor or pharmacist for advice before taking this medicine.

Pregnancy

You should not use this medicine during pregnancy unless this has been discussed with your doctor. The following symptoms may occur in newborn babies of mothers that have used paliperidone in the last trimester (last three months of their pregnancy): shaking, muscle stiffness and/or weakness, sleepiness, agitation, breathing problems, and difficulty feeding. If your baby develops any of these symptoms you may need to contact your doctor.

Breast-feeding

This medicine can pass from mother to baby through breast milk and may harm the baby. Therefore, you should not breastfeed when using this medicine.

Driving and using machines

Dizziness, extreme tiredness and vision problems may occur during treatment with this medicine (see section 4). This should be considered in cases when full alertness is required, e.g. when driving a car or handling machines.

Paliperidone Clonmel contains sodium

This medicine contains less than 1 mmol sodium (23 mg) per dose, that is to say essentially 'sodium-free'.

3. How to use Paliperidone Clonmel

This medicine is administered by your doctor or other health care professional. Your doctor will tell you when you need your next injection. It is important not to miss your scheduled dose. If you cannot keep your appointment with the doctor, make sure you call him right away so another appointment can be

made as soon as possible.

Dosage and method of administration

You will receive the first injection (150 mg) and second injection (100 mg) of this medicine in the upper arm approximately one week apart. Thereafter, you will receive an injection (ranging from 25 mg to 150 mg) in either the upper arm or buttocks once a month.

If your doctor is switching you from risperidone long acting injection to this medicine, you will receive the first injection of this medicine (ranging from 25 mg to 150 mg) in either the upper arm or buttocks on the date that your next injection was scheduled. Thereafter, you will receive an injection (ranging from 25 mg to 150 mg) in either the upper arm or buttocks once a month.

Depending on your symptoms, your doctor may increase or decrease the amount of medicine you receive by one dose level at the time of your scheduled monthly injection.

Patients with kidney problems

Your doctor may adjust your dose of this medicine based on your kidney function. If you have mild kidney problems your doctor may give you a lower dose. If you have moderate or severe kidney problems this medicine should not be used.

Elderly

Your doctor may reduce your dose of this medicine if your kidney function is reduced.

If you are given more Paliperidone Clonmel than needed

This medicine will be given to you under medical supervision; it is, therefore, unlikely that you will be given too much.

Patients who have been given too much paliperidone may experience the following symptoms: drowsiness or sedation, fast heart rate, low blood pressure, an abnormal electrocardiogram (electrical tracing of the heart), or slow or abnormal movements of the face, body, arms or legs.

If you stop using Paliperidone Clonmel

If you stop receiving your injections, you will lose the effects of the medicine. You should not stop using this medicine unless told to do so by your doctor as your symptoms may return.

If you have any further questions on the use of this medicine, ask your doctor or pharmacist.

4. Possible side effects

Like all medicines, this medicine can cause side effects, although not everybody gets them.

Tell your doctor immediately if

- you experience blood clots in the veins, especially in the legs (symptoms include swelling, pain, and redness in the leg), which may travel through blood vessels to the lungs causing chest pain and difficulty breathing. If you notice any of these symptoms seek medical advice immediately
- you have dementia and experience a sudden change in your mental state or sudden weakness or numbness of your face, arms or legs, especially on one side, or slurred speech, even for a short period of time. These may be signs of a stroke
- you experience fever, muscle stiffness, sweating or a lowered level of consciousness (a disorder called “Neuroleptic Malignant Syndrome”). Immediate medical treatment may be needed
- you are a man and experience prolonged or painful erection. This is called priapism. Immediate medical treatment may be needed
- you experience involuntary rhythmic movements of the tongue, mouth and face. Withdrawal of paliperidone may be needed
- you experience a severe allergic reaction characterised by fever, swollen mouth, face, lip or tongue, shortness of breath, itching, skin rash and sometimes a drop in blood pressure (anaphylactic reaction). Even if you have previously tolerated oral risperidone or oral paliperidone, rarely allergic reactions

- can occur after receiving injections of paliperidone
- you are planning to have an operation on your eye, make sure you tell your eye doctor that you are taking this medicine. During an operation on the eye for cloudiness of the lens (cataract), the iris (the coloured part of the eye) may become floppy during surgery (known as “floppy iris syndrome”) and that may lead to eye damage
- tests have shown that you have dangerously low levels of a certain type of white blood cells needed to fight infection in your blood

The following side effects may happen:

Very common side effects: may affect more than 1 in 10 people

- difficulty falling or staying asleep

Common side effects: may affect up to 1 in 10 people

- common cold symptoms, urinary tract infection, feeling like you have the flu
- Paliperidone Clonmel can raise your levels of a hormone called "prolactin" found on a blood test (this may or may not cause symptoms). When symptoms of high prolactin occur, they may include (in men) breast swelling, difficulty in getting or maintaining erections, or other sexual dysfunction; (in women) breast discomfort, leakage of milk from the breasts, missed menstrual periods, or other problems with your cycle
- high blood sugar, weight gain, weight loss, decreased appetite
- irritability, depression, anxiety
- parkinsonism: This condition may include slow or impaired movement, sensation of stiffness or tightness of the muscles (making your movements jerky), and sometimes even a sensation of movement "freezing up" and then restarting. Other signs of parkinsonism include a slow shuffling walk, a tremor while at rest, increased saliva and/or drooling, and a lack of facial expression
- restlessness, feeling sleepy or less alert
- dystonia: this is a condition involving slow or sustained involuntary contraction of muscles. While it can involve any part of the body (and may result in abnormal posture), dystonia often involves muscles of the face, including abnormal movements of the eyes, mouth, tongue or jaw
- dizziness
- dyskinesia: this is a condition involving involuntary muscle movements, and can include repetitive, spastic or writhing movements, or twitching
- tremor (shaking)
- headache
- rapid heart rate
- high blood pressure
- cough, stuffy nose
- abdominal pain, vomiting, nausea, constipation, diarrhoea, indigestion, toothache
- increased liver transaminases in your blood
- bone or muscle ache, back pain, joint pain
- loss of menstrual periods
- fever, weakness, fatigue (tiredness)
- a reaction at the injection site, including itching, pain or swelling

Uncommon side effects: may affect up to 1 in 100 people

- pneumonia, infection of the chest (bronchitis), infection of the breathing passages, sinus infection, bladder infection, ear infection, fungal infection of the nails, tonsillitis, infection of the skin
- white blood cell count decreased, decrease in the type of white blood cells that help to protect you against infection, anaemia
- allergic reaction
- diabetes or worsening of diabetes, increased insulin (a hormone that controls blood sugar levels) in your blood
- increased appetite
- loss of appetite resulting in malnutrition and low body weight

- high blood triglycerides (a type of fat), increased cholesterol in your blood
- sleep disorder, elated mood (mania), decreased sexual drive, nervousness, nightmares
- tardive dyskinesia (twitching or jerking movements that you cannot control in your face, tongue, or other parts of your body). Tell your doctor immediately if you experience involuntary rhythmic movements of the tongue, mouth and face. Withdrawal of this medicine may be needed
- fainting, a restless urge to move parts of your body, dizziness upon standing, disturbance in attention, problems with speech, loss or abnormal sense of taste, reduced sensation of skin to pain and touch, a sensation of tingling, pricking, or numbness of skin
- blurry vision, eye infection or "pink eye", dry eye
- sensation of spinning (vertigo), ringing in the ears, ear pain
- an interruption in conduction between the upper and lower parts of the heart, abnormal electrical conduction of the heart, prolongation of the QT interval from your heart, rapid heartbeat upon standing, slow heart rate, abnormal electrical tracing of the heart (electrocardiogram or ECG), a fluttering or pounding feeling in your chest (palpitations)
- low blood pressure, low blood pressure upon standing (consequently, some people taking this medicine may feel faint, dizzy, or may pass out when they stand up or sit up suddenly)
- shortness of breath, sore throat, nosebleeds
- abdominal discomfort, stomach or intestinal infection, difficulty swallowing, dry mouth,
- excessive passing of gas or wind
- increased GGT (a liver enzyme called gamma-glutamyltransferase) in your blood, increased liver enzymes in your blood
- hives (or "nettle rash"), itching, rash, hair loss, eczema, dry skin, skin redness, acne, abscess under the skin
- an increase of CPK (creatine phosphokinase) in your blood, an enzyme which is sometimes released with muscle breakdown
- muscle spasms, joint stiffness, muscle weakness
- incontinence (lack of control) of urine, frequent passing of urine, pain when passing urine
- erectile dysfunction, ejaculation disorder, missed menstrual periods or other problems with your cycle (females), development of breasts in men, sexual dysfunction, breast pain, leakage of milk from the breasts
- swelling of the face, mouth, eyes, or lips, swelling of the body, arms or legs
- an increase in body temperature
- a change in the way you walk
- chest pain, chest discomfort, feeling unwell
- hardening of the skin
- fall

Rare side effects: may affect up to 1 in 1,000 people

- eye infection
- skin inflammation caused by mites, flaky itchy scalp or skin
- increase in eosinophils (a type of white blood cell) in your blood
- decrease in platelets (blood cells that help you stop bleeding)
- shaking of the head
- inappropriate secretion of a hormone that controls urine volume
- sugar in the urine
- life threatening complications of uncontrolled diabetes
- low blood sugar
- excessive drinking of water
- not moving or responding while awake (catatonia)
- confusion
- sleepwalking
- lack of emotion
- inability to reach orgasm
- neuroleptic malignant syndrome (confusion, reduced or loss of consciousness, high fever, and severe muscle stiffness), blood vessel problems in the brain, including sudden loss of blood supply to brain

(stroke or "mini" stroke), unresponsive to stimuli, loss of consciousness, low level of consciousness, convulsion (fits), balance disorder

- abnormal coordination
- glaucoma (increased pressure within the eyeball)
- problems with movement of your eyes, eye rolling, oversensitivity of the eyes to light, increased tears, redness of the eyes
- atrial fibrillation (an abnormal heart rhythm), irregular heart beat
- blood clot in the lungs causing chest pain and difficulty in breathing. If you notice any of these symptoms seek medical advice immediately
- blood clots in the veins especially in the legs (symptoms include swelling, pain and redness in the leg). If you notice any of these symptoms seek medical advice immediately
- flushing
- trouble breathing during sleep (sleep apnoea)
- lung congestion, congestion of breathing passages
- crackly lung sounds, wheezing
- inflammation of the pancreas, swollen tongue, stool incontinence, very hard stool
- a blockage in the bowels
- chapped lips
- rash on skin related to drug, thickening of skin, dandruff
- breakdown of muscle fibres and pain in muscles (rhabdomyolysis)
- joint swelling
- inability to pass urine
- breast discomfort, enlargement of the glands in your breasts, breast enlargement
- vaginal discharge
- priapism (a prolonged penile erection that may require surgical treatment)
- very low body temperature, chills, feeling thirsty
- symptoms of drug withdrawal
- accumulation of pus caused by infection at injection site, deep skin infection, a cyst at injection site, bruising at injection site

Not known: frequency cannot be estimated from the available data

- dangerously low numbers of a certain type of white blood cell needed to fight infection in your blood
- severe allergic reaction characterised by fever, swollen mouth, face, lip or tongue, shortness of breath, itching, skin rash and sometimes drop in blood pressure
- dangerously excessive intake of water
- sleep-related eating disorder
- coma due to uncontrolled diabetes
- decreased oxygen in parts of your body (because of decreased blood flow)
- fast, shallow breathing, pneumonia caused by inhaling food, voice disorder
- lack of bowel muscle movement that causes blockage
- yellowing of the skin and the eyes (jaundice)
- severe or life-threatening rash with blisters and peeling skin that may start in and around the mouth, nose, eyes and genitals and spread to other areas of the body (Stevens-Johnson syndrome or toxic epidermal necrolysis)
- serious allergic reaction with swelling that may involve the throat and lead to difficulty breathing
- skin discolouration
- abnormal posture
- newborn babies born to mothers who have taken Paliperidone Clonmel during pregnancy may experience side effects of the drug and/or withdrawal symptoms such as irritability, slow, or sustained muscle contractions, shaking, sleepiness, breathing, or feeding problems
- a decrease in body temperature
- dead skin cells at the injection site and an ulcer at the injection site

Reporting of side effects

If you get any side effects, talk to your doctor, pharmacist or nurse. This includes any possible side

effects not listed in this leaflet. You can also report side effects directly via:

Ireland:

HPRA Pharmacovigilance

Website: www.hpra.ie

Malta:

ADR Reporting

Website: www.medicinesauthority.gov.mt/adrportal

By reporting side effects you can help provide more information on the safety of this medicine.

5. How to store Paliperidone Clonmel

Keep this medicine out of the sight and reach of children.

Do not use this medicine after the expiry date which is stated on the carton and on the pre-filled syringe. The expiry date refers to the last day of that month.

This medicine does not require any special storage conditions.

Do not throw away any medicines via wastewater or household waste. Ask your pharmacist how to throw away medicines you no longer use. These measures will help to protect the environment.

6. Contents of the pack and other information

What Paliperidone Clonmel contains

The active substance is paliperidone.

Each Paliperidone Clonmel 50 mg pre-filled syringe contains paliperidone palmitate equivalent to 50 mg paliperidone.

Each Paliperidone Clonmel 75 mg pre-filled syringe contains paliperidone palmitate equivalent to 75 mg paliperidone.

Each Paliperidone Clonmel 100 mg pre-filled syringe contains paliperidone palmitate equivalent to 100 mg paliperidone.

Each Paliperidone Clonmel 150 mg pre-filled syringe contains paliperidone palmitate equivalent to 150 mg paliperidone.

The other ingredients are

Polysorbate 20 (E 432)

Macrogol

Citric acid monohydrate (E 330)

Disodium phosphate (E 339)

Sodium dihydrogen phosphate monohydrate

Sodium hydroxide (E 542) (for pH adjustment)

Water for injections

What Paliperidone Clonmel looks like and contents of the pack

Paliperidone Clonmel is a white to off-white prolonged-release suspension for injection in a pre-filled syringe.

The pre-filled syringe consists of cyclic olefin copolymer with plunger rod and a flange extender/backstop with a plunger stopper (bromo butyl rubber).

Each single pack contains 1 prefilled syringe and 2 needles.

Marketing Authorisation Holder

Clonmel Healthcare Ltd, Waterford Road, Clonmel, Co. Tipperary, Ireland

Manufacturer

STADA Arzneimittel AG, Stadastrasse 2-18, 61118 Bad Vilbel, Germany

STADA Arzneimittel GmbH, Muthgasse 36/2, 1190 Wien, Austria

This medicine is authorised in the Member States of the European Economic Area under the following names:

Austria:	Paliperidon STADA 50 mg, 75 mg, 100 mg, 150 mg Depot-Injektionssuspension Paliperidon STADA Starterpackung 100 mg + 150 mg Depot-Injektionssuspension
Belgium:	Paliperidon EG 25 mg, 50 mg, 75 mg, 100 mg, 150 mg suspensie voor injectie met verlengde afgifte in een voorgevulde spuit Paliperidon EG 150 mg + 100 mg suspensie voor injectie met verlengde afgifte in een voorgevulde spuit
Cyprus:	Paliperidone Palmitate /STADA
Denmark:	Paliperidone STADA 25 mg, 50 mg, 75 mg, 100 mg, 150 mg
Germany:	Paliperidon AL 25 mg, 50 mg, 75 mg, 100 mg, 150 mg Depot-Injektionssuspension Paliperidon AL 150 mg und 100 mg Depot-Injektionssuspension
Greece:	Paliperidone Palmitate /STADA
Finland:	Paliperidone STADA 25 mg, 50 mg, 75 mg, 100 mg, 150 mg injektioneste, depotsuspensio
France:	PALIPERIDONE EG 25 mg, 50 mg, 75 mg, 100 mg, 150 mg, suspension injectable à libération prolongée PALIPERIDONE EG 150 mg et PALIPERIDONE EG 100 mg, suspension injectable à libération prolongée
Hungary:	Paliperidone Stada 25 mg, 50 mg, 75 mg, 100 mg, 150 mg retard szuszpenziós injekció Paliperidone Stada 150 mg és Paliperidone Stada 100 mg retard szuszpenziós injekció
Iceland:	Paliperidone STADA 25 mg, 50 mg, 75 mg, 100 mg, 150 mg stungulyf, forðadreifa
Ireland:	Paliperidone Clonmel 50 mg, 75 mg, 100 mg, 150 mg prolonged-release suspension for injection in pre-filled syringe
Italy:	Paliperidone EG
Luxembourg:	Paliperidon EG 25 mg, 50 mg, 75 mg, 100 mg, 150 mg suspension injectable à libération prolongée en seringue préremplie Paliperidon EG 150 mg + 100 mg suspension injectable à libération prolongée en seringue préremplie
Malta:	Paliperidone Clonmel 50 mg, 75 mg, 100 mg, 150 mg prolonged-release suspension for injection in pre-filled syringe
Netherlands:	Paliperidon CF 25 mg, 50 mg, 75 mg, 100 mg, 150 mg, suspensie voor injectie met verlengde afgifte in een voorgevulde spuit Paliperidon CF 100 mg + 150 mg, suspensie voor injectie met verlengde afgifte in een voorgevulde spuit
Norway:	Paliperidone STADA
Portugal:	Paliperidona STADA
Romania:	Paliperidonă Stada 25 mg, 50 mg, 75 mg, 100 mg, 150 mg suspensie injectabilă cu eliberare prelungită în seringă preumplută
Slovakia:	Paliperidón STADA 25 mg, 50 mg, 75 mg, 100 mg, 150 mg injekčná suspenzia s predĺženým uvoľňovaním v naplnenej injekčnej striekačke Paliperidón STADA 150 mg+100 mg injekčná suspenzia s predĺženým uvoľňovaním v naplnenej injekčnej striekačke
Spain:	Paliperidona STADA 50 mg, 75 mg, 100 mg, 150 mg suspensión inyectable de liberación prolongada en jeringa precargada EFG
Sweden:	Paliperidone STADA

This leaflet was last revised in March 2024.

The following information is intended for medical or healthcare professionals only and should be read by the medical or healthcare professional in conjunction with the full prescribing information (Summary of Product Characteristics).

The suspension for injection is for single use only. It should be inspected visually for foreign matter before administration. Do not use if the syringe is not visually free of foreign matter.

The pack contains a pre-filled syringe and 2 safety needles (a 1½-inch 22 gauge needle [38 mm x 0.7 mm] and a 1-inch 23 gauge needle [25 mm x 0.6 mm]) for intramuscular injection.

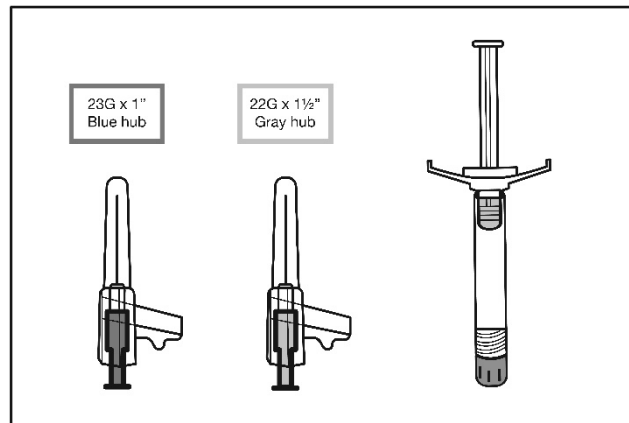

1. Shake the syringe vigorously for a minimum of 10 seconds to ensure a homogeneous suspension.

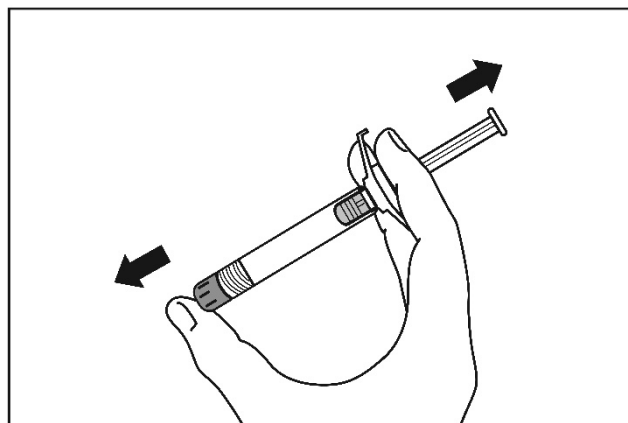

2. Select the appropriate needle.

The first initiation dose of Paliperidone Clonmel (150 mg) is to be administered on Day 1 in the DELTOID muscle using the needle for DELTOID injection. The second initiation dose of Paliperidone Clonmel (100 mg) is to also be administered in the DELTOID muscle one week later (Day 8) using the needle for DELTOID injection.

If the patient is being switched from risperidone long acting injection to Paliperidone Clonmel, the first injection of Paliperidone Clonmel (ranging from 25 mg to 150 mg) can be administered in either the DELTOID or GLUTEAL muscle using the appropriate needle for the injection site at the time of the next scheduled injection.

Thereafter, the monthly maintenance injections can be administered in either the DELTOID or GLUTEAL muscle using the appropriate needle for the injection site.

For DELTOID injection, if the patient weighs < 90 kg, use the 1-inch, **23** gauge needle (25 mm x 0.6 mm) (needle with **blue** coloured hub); if the patient weighs ≥ 90 kg, use the 1½-inch, **22** gauge needle (38 mm x 0.7 mm) (needle with **grey** coloured hub).

For GLUTEAL injection, use the 1½-inch, **22** gauge needle (38 mm x 0.7 mm) (needle with grey coloured hub).

3. While holding the syringe upright, remove the rubber tip cap with a twisting motion.

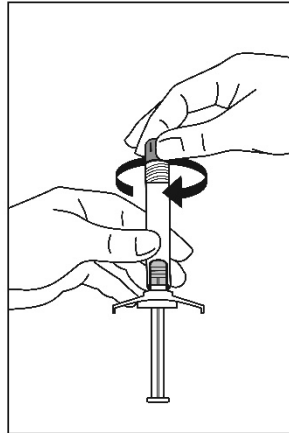

4. Peel the safety needle blister pouch half way open. Grasp the needle sheath using the plastic peel pouch. Attach the safety needle to the luer connection of the syringe with an easy clockwise twisting motion.

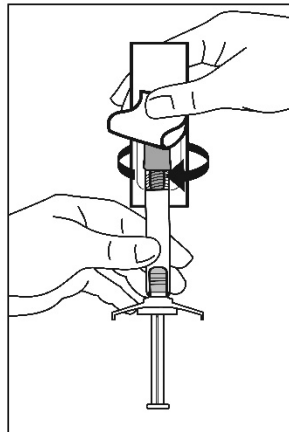

5. Pull the needle sheath away from the needle with a straight pull. Do not twist the sheath as the needle may be loosened from the syringe.

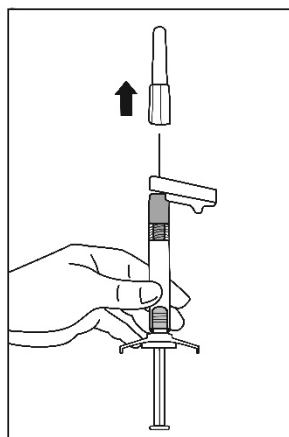

6. Bring the syringe with the attached needle in upright position to de-aerate. De-aerate the syringe by

moving the plunger rod carefully forward.

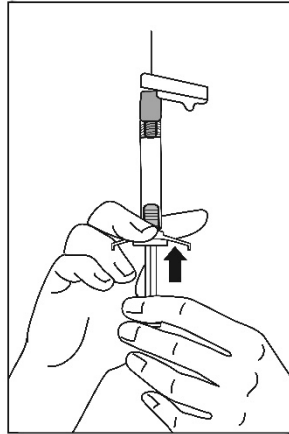

7. Inject the entire contents intramuscularly slowly, deep into the selected deltoid or gluteal muscle of the patient. **Do not administer intravascularly or subcutaneously.**
8. After the injection is complete, use either thumb or finger of one hand (8a, 8b) or a flat surface (8c) to activate the needle protection system. The system is fully activated when a 'click' is heard. Discard the syringe with needle appropriately.

8a

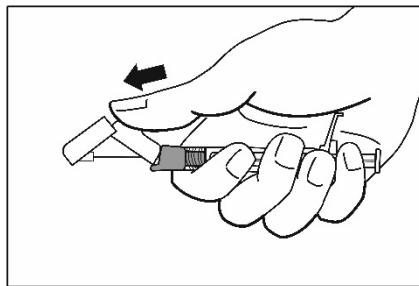

8b

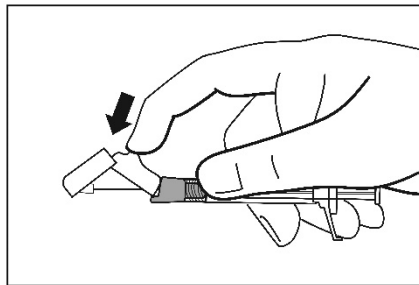

8c

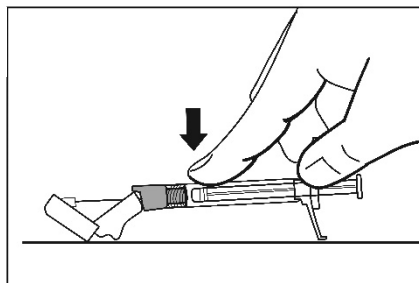

Any unused product or waste material should be disposed of in accordance with local requirements.