

## Package leaflet: Information for the user

### Kyleena 19.5 mg intrauterine delivery system

levonorgestrel

**Read all of this leaflet carefully before you start using this medicine because it contains important information for you.**

- Keep this leaflet. You may need to read it again.
- If you have any further questions, ask your doctor or nurse.
- This medicine has been prescribed for you only. Do not pass it on to others.
- If you get any side effects, talk to your doctor or nurse. This includes any possible side effects not listed in this leaflet. See section 4.

#### What is in this leaflet

1. What Kyleena is and what it is used for
2. What you need to know before you use Kyleena
3. How to use Kyleena
4. Possible side effects
5. How to store Kyleena
6. Contents of the pack and other information

#### 1. What Kyleena is and what it is used for

Kyleena is used for the prevention of pregnancy (contraception) for up to five years.

Kyleena is a T-shaped intrauterine delivery system (IUS) which after placement inside the womb slowly releases a small amount of the hormone levonorgestrel.

Kyleena works by reducing the monthly growth of the lining of the womb and thickening the cervical mucus. These actions prevent the sperm and egg from coming into contact and so prevent fertilization of an egg by sperm.

#### 2. What you need to know before you use Kyleena

##### General notes

Before you can begin using Kyleena, your healthcare professional will ask you some questions about your personal health history.

In this leaflet, several situations are described where Kyleena should be removed, or where the reliability of Kyleena may be decreased. In such situations you should either not have intercourse or you should use a condom or another barrier method.

Kyleena, like other hormonal contraceptives, does not protect against HIV infection (AIDS) or any other sexually transmitted disease.

Kyleena is not suitable for use as an emergency contraceptive (postcoital contraceptive).

**Do NOT use Kyleena if you:**

- are pregnant (see section “Pregnancy, breast-feeding and fertility”)
- currently have a pelvic inflammatory disease (PID; infection of the female reproduction organs) or have had this condition multiple times in the past.
- have conditions associated with increased susceptibility to pelvic infections
- have an infection in the lower genital tract (an infection in the vagina or the cervix [neck of the womb])
- have had an infection of the womb after delivery of a child, after an abortion or after miscarriage during the past 3 months
- currently have cell abnormalities in the cervix
- have cancer or suspected cancer of the cervix or womb
- have tumours which are sensitive to progestogen hormones to grow, e.g. breast cancer
- have unexplained uterine bleeding
- have an abnormality of the cervix or womb including fibroids that distort the cavity of the womb
- have an active liver disease or liver tumour
- are allergic to levonorgestrel or any of the other ingredients of this medicine (listed in section 6).

**Warnings and precautions****Talk to your healthcare professional before using Kyleena if you:**

- have diabetes. There is generally no need to alter your diabetic medication while using Kyleena, but this may need to be checked by your healthcare professional.
- have epilepsy. A fit (seizure) can occur during placement or removal.
- have had an ectopic or extrauterine pregnancy (pregnancy outside the womb) in the past.

In addition, also talk to your healthcare professional if any of the following conditions exist before you use Kyleena or appear for the first time while using Kyleena:

- migraine, with visual disturbances or other symptoms which may be signs of a transient cerebral ischemia (temporary blockage of the blood supply to the brain)
- exceptionally severe headache
- jaundice (a yellowing of the skin, whites of the eyes and/or nails)
- marked increase in blood pressure
- severe disease of the arteries such as stroke or heart attack.

The following signs and symptoms could mean that you may have an extrauterine pregnancy and you should see your healthcare professional immediately (see also section “Pregnancy, breast-feeding and fertility”):

- your menstrual periods have stopped and then you start having persistent bleeding or pain
- you have pain in your lower abdomen that is severe or persistent
- you have normal signs of pregnancy, but you also have bleeding and feel dizzy
- you have a positive pregnancy test

Contact your healthcare professional promptly if any of the following occur (see also section 4):

- severe pain (like menstrual cramps) or heavy bleeding after placement or if you have pain/bleeding which continues for more than a few weeks. This may be for example a sign of infection, perforation or that Kyleena is not in the correct position.
- you no longer feel the threads in your vagina. This may be a sign of expulsion or perforation. You can check by gently putting a finger into your vagina and feeling for the threads at the end of your vagina near the opening of your womb (cervix). Do not pull the threads because you may accidentally pull out Kyleena. Use a barrier contraceptive (such as condoms) until your healthcare professional has checked that the IUS is still in position.
- you or your partner can feel the lower end of Kyleena. Avoid intercourse until your healthcare professional has checked that the IUS is still in position.
- your partner feels the removal threads during intercourse.
- you think you may be pregnant
- you have persistent abdominal pain, fever, or unusual discharge from the vagina, which may be a sign of infection. Infections must be treated immediately.
- you feel pain or discomfort during sexual intercourse, which may be for example a sign of infection, ovarian cyst or that Kyleena is not in the correct position.
- there are sudden changes in your menstrual periods (for example, if you have little or no menstrual bleeding, and then you start having persistent bleeding or pain, or you start bleeding heavily), which may be a sign of Kyleena not being in the correct position or expelled.

Use of sanitary pads is recommended. If tampons or menstrual cups are used, you should change them with care so as not to pull the threads of Kyleena. If you think you may have pulled Kyleena out of place (see list above for possible signs), avoid intercourse or use a barrier contraceptive (such as condoms), and contact your healthcare professional.

### ***Psychiatric disorders***

Some women using hormonal contraceptives including Kyleena have reported depression or depressed mood. Depression can be serious and may sometimes lead to suicidal thoughts. If you experience mood changes and depressive symptoms contact your doctor for further medical advice as soon as possible.

### **Children and adolescents**

Kyleena is not indicated for use before the first menstrual bleeding (menarche).

### **Other medicines and Kyleena**

Tell your healthcare professional if you are taking, have recently taken or might take any other medicines.

## **Pregnancy, breast-feeding and fertility**

### ***Pregnancy***

Kyleena must not be used during pregnancy.

Some women may not have their periods while using Kyleena. Not having a period is not necessarily a sign of pregnancy. If you do not have your period and have other symptoms of pregnancy you should see your healthcare professional for an examination and have a pregnancy test.

If you have not had a period for 6 weeks and are concerned, then consider having a pregnancy test. If this is negative, there is no need to carry out another test unless you have other signs of pregnancy.

If you become pregnant with Kyleena in place, you should see your healthcare professional immediately to have Kyleena removed. The removal may cause a miscarriage. However, if Kyleena is left in place during pregnancy, not only is the risk of having a miscarriage higher, but also the risk of preterm labour. If Kyleena cannot be removed, talk with your healthcare professional about the benefits and risks of continuing the pregnancy. If the pregnancy is continued, you will be closely monitored during your pregnancy and you should contact your healthcare professional right away if you experience stomach cramps, pain in your stomach or fever.

Kyleena contains a hormone, called levonorgestrel, and there have been isolated reports of effects on the genitalia of female babies if exposed to levonorgestrel intra-uterine devices while in the womb.

If you want to become pregnant you should contact your healthcare professional to have Kyleena removed.

### ***Extrauterine pregnancy (pregnancy outside the womb)***

It is uncommon to become pregnant while using Kyleena. However, if you become pregnant while using Kyleena, the risk that the pregnancy could develop outside the womb (have an extrauterine or ectopic pregnancy) is increased. Women who have already had an extrauterine pregnancy, surgery of the fallopian tubes or a pelvic infection carry a higher risk for this type of pregnancy. An extrauterine pregnancy is a serious condition which calls for immediate medical attention (see section 2, “Warnings and precautions for signs and symptoms”) and may impact future fertility.

### ***Breast-feeding***

You can use Kyleena during breast-feeding. Levonorgestrel (the active ingredient in Kyleena) has been identified in small quantities in the breast milk of breast-feeding women. However, no negative effects have been seen on infant growth and development or the amount or the quality of the breast milk.

### ***Fertility***

Your usual level of fertility will return after Kyleena is removed.

## **Driving and using machines**

Kyleena has no known influence on the ability to drive or use machines.

### **3. How to use Kyleena**

#### **Placement of Kyleena**

Kyleena can either be placed:

- within 7 days from the start of your menstrual bleed (your monthly period)
- immediately after a first trimester abortion provided that there are no genital infections
- after giving birth only after the womb has returned to its normal size, and not earlier than 6 weeks after delivery (see section 4 “Possible side effects-Perforation”).

Examination by your healthcare professional before placement may include:

- a cervical smear test (Pap smear)
- examination of the breasts
- other tests, e.g. for infections, including sexually transmitted diseases, as necessary. Your healthcare professional will also do a gynaecological examination to determine the position and size of the womb.

After a gynaecological examination:

- an instrument called a speculum is placed into the vagina, and the cervix may be cleansed with an antiseptic solution. Kyleena is then placed into the womb using a thin, flexible plastic tube (the placement tube). Local anaesthesia may be applied to the cervix prior to placement.
- some women feel dizzy or faint during placement or after Kyleena is placed or removed.
- you may experience some pain and bleeding during or just after placement.

After placement of Kyleena you should receive a patient reminder card from your doctor for follow-up examinations. Bring this with you to every scheduled appointment.

#### **Follow-up examination:**

You should have your Kyleena checked 4-6 weeks after placement, and thereafter regularly, at least once a year. Your doctor may determine how often and what kinds of check-ups are required in your particular case. Bring the patient reminder card you have received from your doctor to every scheduled appointment.

#### **Removal of Kyleena**

Kyleena should be removed no later than the end of the fifth year of use.

Kyleena can be easily removed at any time by your healthcare professional, after which pregnancy is possible. Some women feel dizzy or faint during or after Kyleena is removed. You may experience some pain and bleeding during removal of Kyleena.

If pregnancy is not desired, Kyleena should not be removed after the seventh day of the menstrual cycle (monthly period) unless you use other methods of contraception (e.g. condoms) for at least 7 days before the IUS removal.

If you have irregular periods (menses) or no periods, you should use a barrier method of contraception for 7 days before removal.

A new Kyleena can also be placed immediately after removal, in which case no additional protection is needed.

#### 4. Possible side effects

Like all medicines, this medicine can cause side effects, although not everybody gets them.

Contact your healthcare professional immediately if you notice any of the following symptoms:

- allergic reactions including rash, hives (urticaria) and angioedema (characterized by sudden swelling of e.g. the eyes, mouth, throat)

See also section 2 for when to contact your healthcare professional promptly.

The following is a list of possible side effects by how common they are:

**Very common side effects:** may affect more than 1 in 10 people

- headache
- abdominal/pelvic pain
- acne/greasy skin
- bleeding changes including increased and decreased menstrual bleeding, spotting, infrequent periods and absence of bleeding (see also following section on irregular and infrequent bleeding)
- ovarian cyst (see also following section on ovarian cyst)
- inflammation of the external genital organs and vagina (vulvovaginitis)

**Common side effects:** may affect up to 1 in 10 people

- depressed mood/depression
- decreased libido
- migraine
- dizziness
- feeling sick (nausea)
- hair loss
- upper genital tract infection
- painful menstruation
- breast pain/discomfort
- device expulsion (complete and partial) - (see the following section on expulsion)
- genital discharge
- increased weight

**Uncommon side effects:** may affect up to 1 in 100 people

- excessive body hair
- perforation of the womb (see also following section on perforation)

## **Description of selected possible side effects:**

### ***Irregular or infrequent bleeding***

Kyleena is likely to affect your menstrual cycle. It can change your menstrual periods so that you have spotting (a small amount of bleeding), irregular, shorter or longer periods, lighter or heavier bleeding, or no bleeding at all.

You may have bleeding and spotting between menstrual periods, especially during the first 3 to 6 months. Sometimes the bleeding is heavier than usual at first.

Overall, you are likely to have a gradual reduction in the amount and number of days of bleeding each month. Some women eventually find that periods stop altogether.

The monthly thickening of the lining of the womb may not happen due to the effect of the hormone and therefore there is nothing to come or shed away as a menstrual period. It does not necessarily mean that you have reached menopause or are pregnant. Your own hormone levels usually remain normal.

When the system is removed, your period should soon return to normal.

### ***Pelvic Infection***

The Kyleena inserter and Kyleena itself are sterile. Despite this, there is an increased risk of pelvic infection (infections in the lining of the womb or the fallopian tubes) at the time of placement and during the first 3 weeks after the placement.

Pelvic infections in IUS users are often related to the presence of sexually transmitted diseases. The risk of infection is increased if you or your partner have multiple sexual partners or if you have had pelvic inflammatory disease (PID) before.

Pelvic infections must be treated promptly.

Pelvic infections such as PID may have serious consequences and it may impair fertility and increase the risk of a future extrauterine pregnancy (pregnancy outside the womb). In extremely rare cases severe infection or sepsis (very severe infection, which may be fatal) can occur shortly after insertion.

Kyleena must be removed if you experience recurring PID or if an infection is severe or does not respond to treatment.

### ***Expulsion***

The muscular contractions of the womb during menstruation may sometimes push the IUS out of place or expel it. This is more likely to occur if you are overweight at the time of IUS insertion or have a history of heavy periods. If the IUS is out of place, it may not work as intended and therefore, the risk of pregnancy is increased. If the IUS is expelled, you are not protected against pregnancy anymore.

Possible symptoms of an expulsion are pain and abnormal bleeding but Kyleena may also come out without you noticing. As Kyleena decreases menstrual flow, increase of menstrual flow may be indicative of an expulsion.

It is recommended that you check for the threads with your finger, for example while having a shower. See also section 2 “Warnings and precautions” for how to check if Kyleena is in place. If you have signs indicative of an expulsion or you cannot feel the threads, you should use another contraceptive (such as condoms), and consult your healthcare professional.

## ***Perforation***

Penetration or perforation of the wall of the womb may occur during placement of Kyleena, although the perforation may not be detected until some time later. If Kyleena becomes lodged outside the cavity of the womb, it is not effective at preventing pregnancy and it must be removed as soon as possible. You may need surgery to have Kyleena removed. The risk of perforation is increased in breast-feeding women and in women who have insertion up to 36 weeks after birth, and may be increased in women with the uterus fixed and leaning backwards (fixed retroverted uterus). If you suspect you may have experienced a perforation, seek prompt advice from a healthcare provider and remind them that you have Kyleena inserted, especially if they were not the person who inserted it.

## ***Ovarian cyst***

Since the contraceptive effect of Kyleena is mainly due to its local effect in the womb, ovulation (release of the egg) usually continues while using Kyleena. Sometimes an ovarian cyst may develop. In most cases there are no symptoms.

An ovarian cyst may require medical attention, or more rarely surgery, but it usually disappears on its own.

## **Reporting of side effects**

If you get any side effects, talk to your doctor or nurse. This includes any possible side effects not listed in this leaflet. You can also report side effects directly via HPRA

Pharmacovigilance. Website: [www.hpra.ie](http://www.hpra.ie). By reporting side effects you can help provide more information on the safety of this medicine.

## **5. How to store Kyleena**

This medicinal product does not require any special storage conditions.

Keep this medicine out of the sight and reach of children.

Do not open the blister. Only your doctor or nurse should do this.

Do not use this medicine after the expiry date which is stated on the carton and the blister after EXP. The expiry date refers to the last day of that month.

## **6. Contents of the pack and other information**

### **What Kyleena contains**

The **active substance** is levonorgestrel. The intrauterine delivery system contains 19.5 mg levonorgestrel.



The **other ingredients** are:

- polydimethylsiloxane elastomer
- silica, colloidal anhydrous
- polyethylene
- barium sulfate
- polypropylene
- copper phthalocyanine
- silver

### **What Kyleena looks like and contents of the pack**

Kyleena is a T-shaped intrauterine delivery system (IUS). The vertical arm of the white T-body carries a drug reservoir containing levonorgestrel. Two blue removal threads are tied to the loop at the lower end of the vertical arm. In addition, the vertical stem contains a silver ring located close to the horizontal arms, which is visible under ultrasound examination.

Pack size:

- 1x1 intrauterine delivery system.
- 5x1 intrauterine delivery system.

Not all pack sizes may be marketed.

### **Marketing Authorisation Holder**

Bayer Limited  
1st Floor  
The Grange Offices  
The Grange  
Brewery Road  
Stillorgan  
Co. Dublin  
A94 H2K7  
Ireland

### **Manufacturer**

Bayer OY  
Pansiontie 47  
20210 Turku  
Finland

**This medicine is authorised in the Member States of the European Economic Area under the following names:**

- Austria, Belgium, Czech Republic, Denmark, Estonia, Finland, France, Germany, Iceland, Ireland, Italy, Latvia, Lithuania, The Netherlands, Norway, Poland, Portugal, Slovenia, Spain, Sweden: **Kyleena**

**This leaflet was last revised in September 2022.**

### **Other sources of information**

Detailed and updated information on this medicine is available by scanning the QR Code included in the package leaflet, outer carton and patient reminder card with a smartphone. The same information is also available on the following URL: [www.pi.bayer.com/kyleena/ie](http://www.pi.bayer.com/kyleena/ie) and on the HPRRA website at [www.hpra.ie](http://www.hpra.ie)

[QR code to package leaflet to be included nationally]

---

The following information is intended for healthcare professionals only:

## **INSERTION INSTRUCTIONS**

Kyleena 19.5 mg intrauterine delivery system  
levonorgestrel

To be inserted by a healthcare professional using aseptic technique.

Kyleena is supplied in a sterile package within an integrated inserter that enables single handed loading. The package should not be opened until needed for insertion. Do not resterilize. As supplied, Kyleena is for single use only. Do not use if the blister is damaged or open. Do not insert after the expiry date which is stated on the carton and the blister after EXP.

Any unused product or waste material should be disposed of in accordance with local requirements.

Kyleena is supplied with a patient reminder card in the outer package. Complete the patient reminder card and give it to the patient, after insertion.

### *Preparation for insertion*

- Examine the patient to establish the size and position of the uterus, in order to detect any signs of acute genital infections or other contraindications for the insertion of Kyleena. If there is any doubt regarding pregnancy, a pregnancy test should be performed.
- Insert a speculum, visualize the cervix, and then thoroughly cleanse the cervix and vagina with a suitable antiseptic solution.
- Employ an assistant as necessary.
- Grasp the anterior lip of the cervix with a tenaculum or other forceps to stabilize the uterus. If the uterus is retroverted, it may be more appropriate to grasp the posterior lip of the cervix. Gentle traction on the forceps can be applied to straighten the cervical canal. The forceps should remain in position and gentle counter traction on the cervix should be maintained throughout the insertion procedure.
- Advance a uterine sound through the cervical canal to the fundus to measure the depth and confirm the direction of the uterine cavity and to exclude any evidence of intrauterine abnormalities (e.g., septum, submucous fibroids) or a previously inserted intrauterine contraceptive which has not been removed. If difficulty is encountered, consider dilatation of the canal. If cervical dilatation is required, consider using analgesics and/or a paracervical block.

*Insertion*

1. First, open the sterile package completely (Figure 1). Then use aseptic technique and sterile gloves.

Figure 1

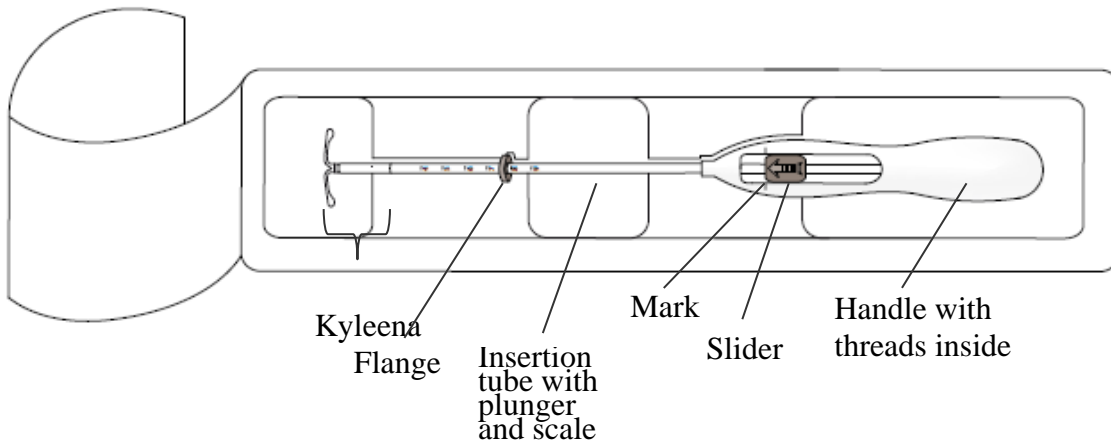

2. Push the slider **forward** in the direction of the arrow to the furthest position to load Kyleena into the insertion tube (Figure 2).

Figure 2

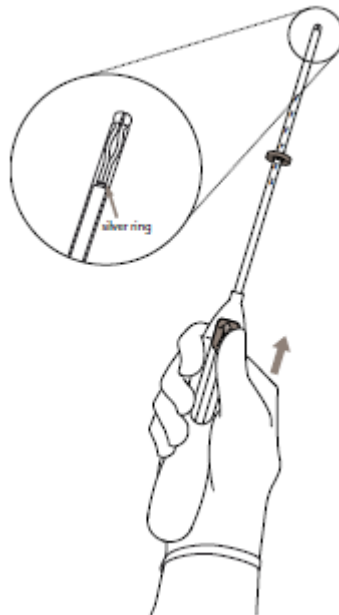

**IMPORTANT!** Do not pull the slider downwards as this may prematurely release Kyleena. Once released, Kyleena cannot be re-loaded.

3. Holding the slider in the furthest position, set the **upper** edge of the flange to correspond to the sound measurement of the uterine depth (Figure 3).

Figure 3

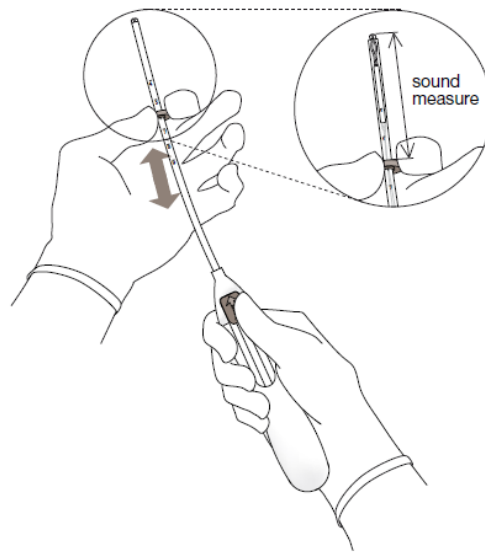

4. While holding the slider in the **furthest** position, advance the inserter through the cervix until the flange is approximately 1.5-2.0 cm from the uterine cervix (Figure 4).

Figure 4

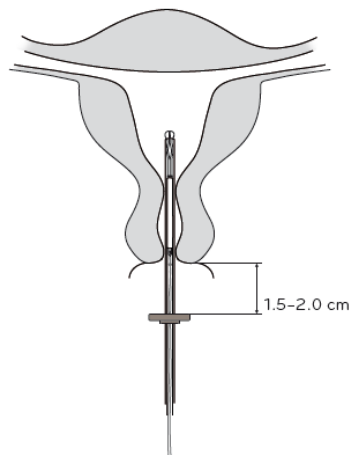

**IMPORTANT!** Do not force the inserter. Dilate the cervical canal, if necessary.

5. While holding the inserter steady, **pull the slider to the mark** to open the horizontal arms of Kyleena (Figure 5). Wait 5-10 seconds for the horizontal arms to open completely.

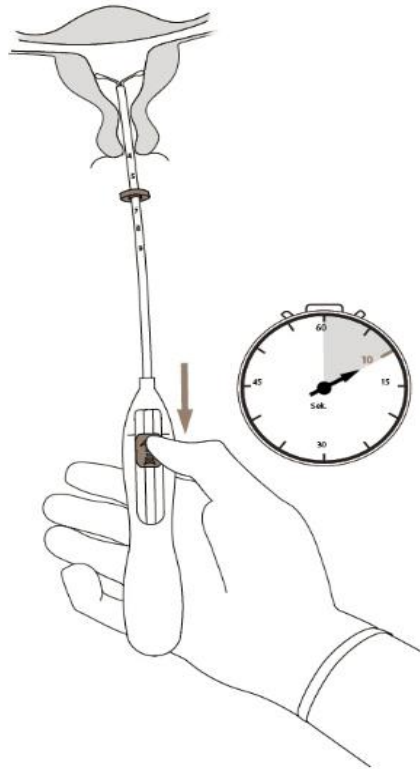

Figure 5

6. Advance the inserter gently towards the fundus of the uterus **until the flange touches the cervix**. Kyleena is now in the fundal position (Figure 6).

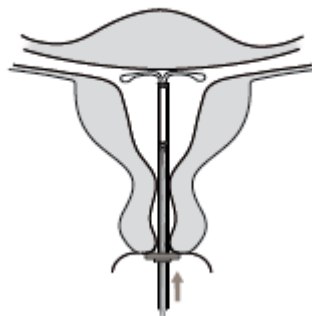

Figure 6

7. Holding the inserter in place, release Kyleena by pulling **the slider all the way down** (Figure 7). While holding the slider all the way down, gently remove the inserter by pulling it out. **Cut the threads** to leave about 2-3 cm visible outside of the cervix.

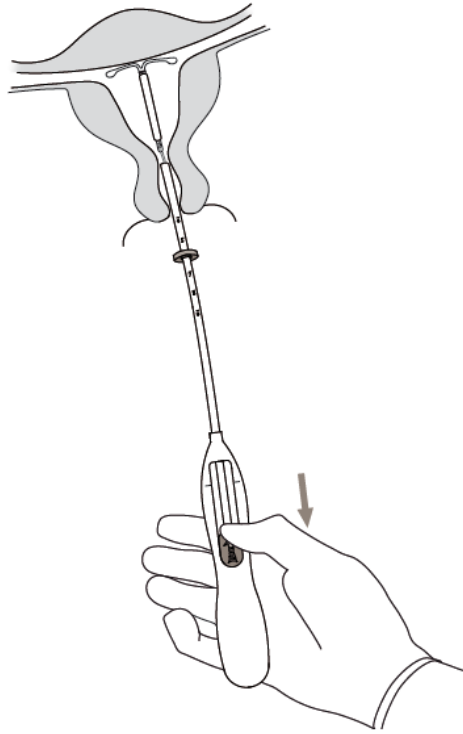

Figure 7

**IMPORTANT!** Should you suspect that the system is not in the correct position, check placement (e.g. with ultrasound). Remove the system if it is not positioned properly within the uterine cavity. A removed system must not be re-inserted.

### **Removal/replacement**

For removal/replacement, please consult the Summary of Product Characteristics for Kyleena.

Kyleena is removed by pulling on the threads with a forceps (Figure 8).

You may insert a new Kyleena immediately following removal.

After removal of Kyleena, the system should be examined to ensure that it is intact.

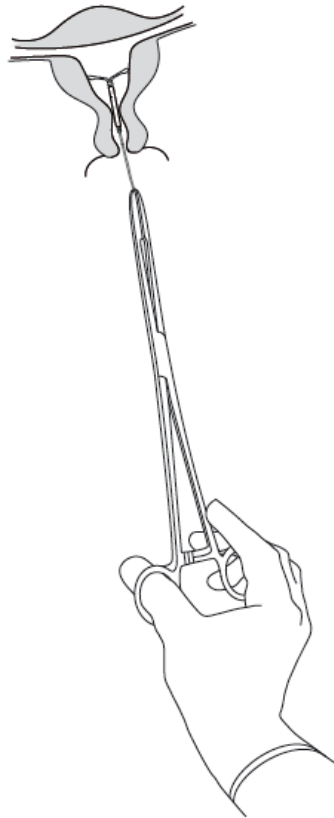

Figure 8

[QR code to Summary of Product Characteristics to be included nationally]  
Summary of Product Characteristics for Kyleena online at [www.pi.bayer.com/kyleena/ie](http://www.pi.bayer.com/kyleena/ie)